

# FARFISA BALLATA

- A to B  
 D<sub>o</sub> 330n  
 D<sub>o</sub>' 270n  
 R<sub>e</sub> 220n  
 R<sub>e</sub>' 180n  
 M<sub>i</sub> 150n  
 F<sub>a</sub> 120n  
 F<sub>a</sub>' 100n  
 S<sub>ol</sub> 68n  
 S<sub>ol</sub>' DC  
 L<sub>a</sub> DC  
 L<sub>a</sub>' DC  
 S<sub>i</sub> DC

NB. No Condenser 50nF 12WV on generator boards - SOL LA-LA-SI

\*D.C. direct connection

2u  
1g

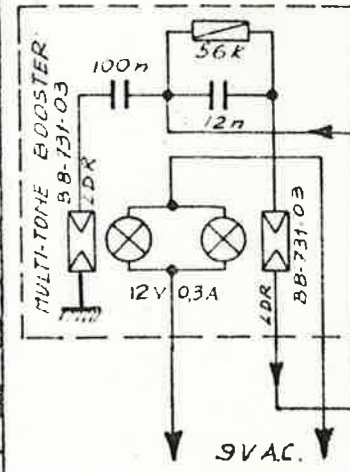
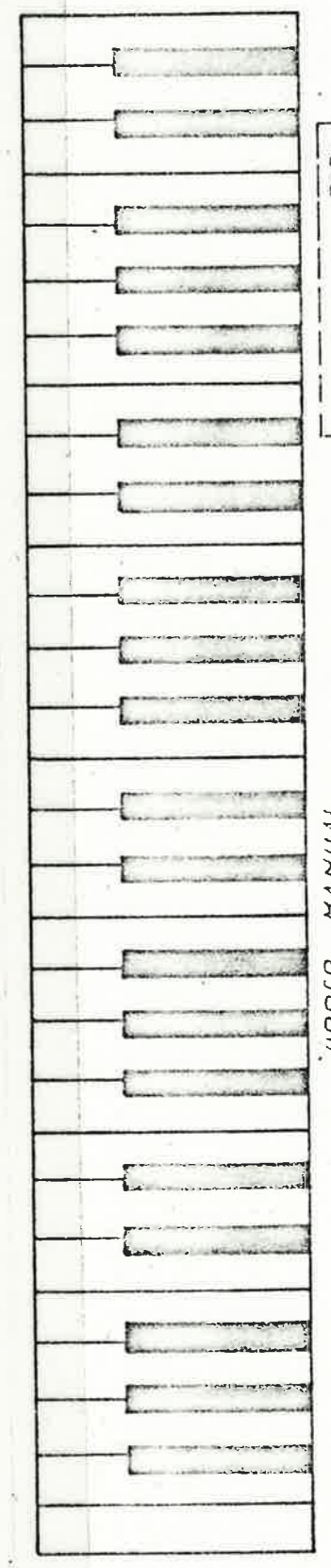
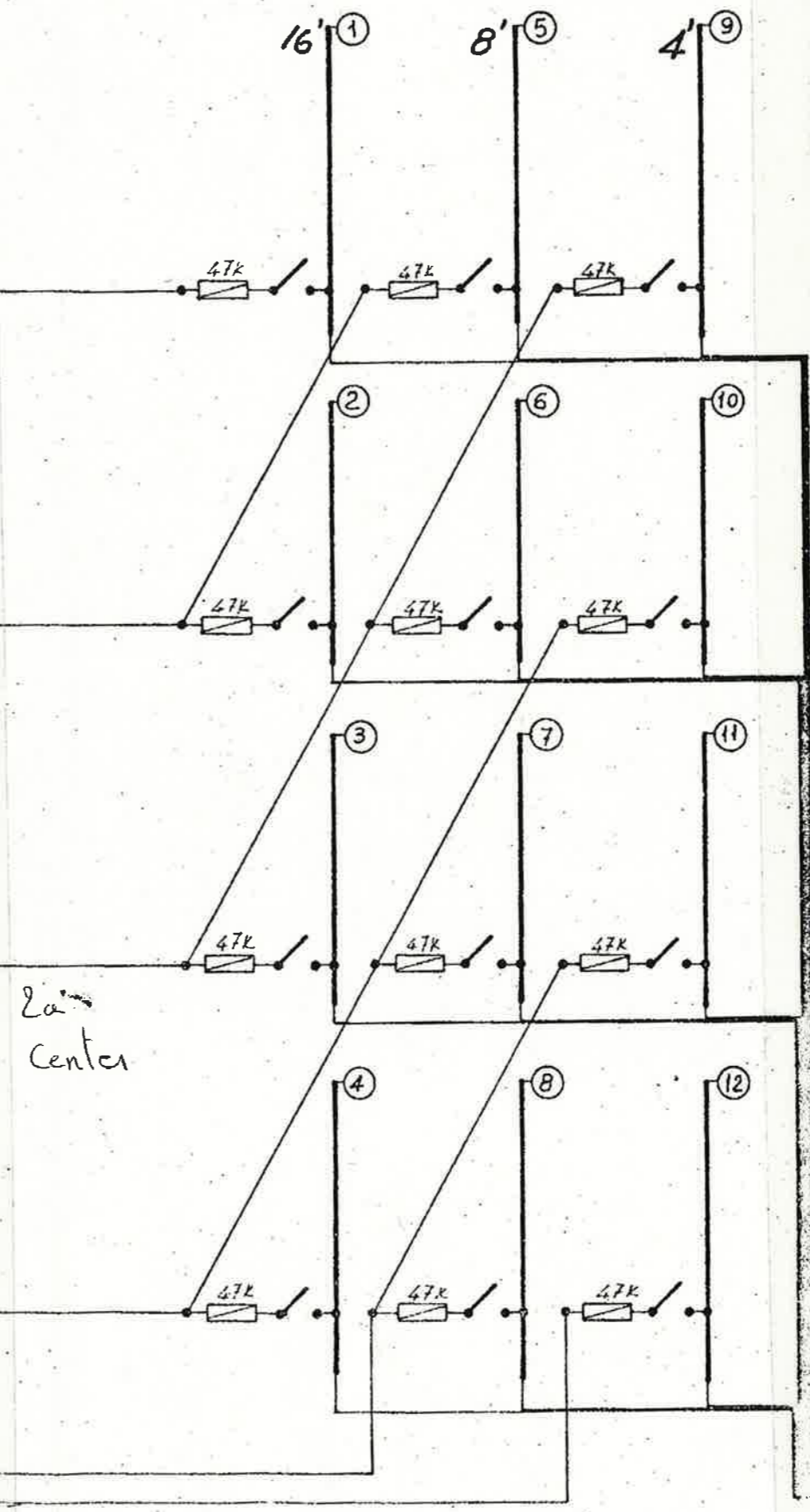
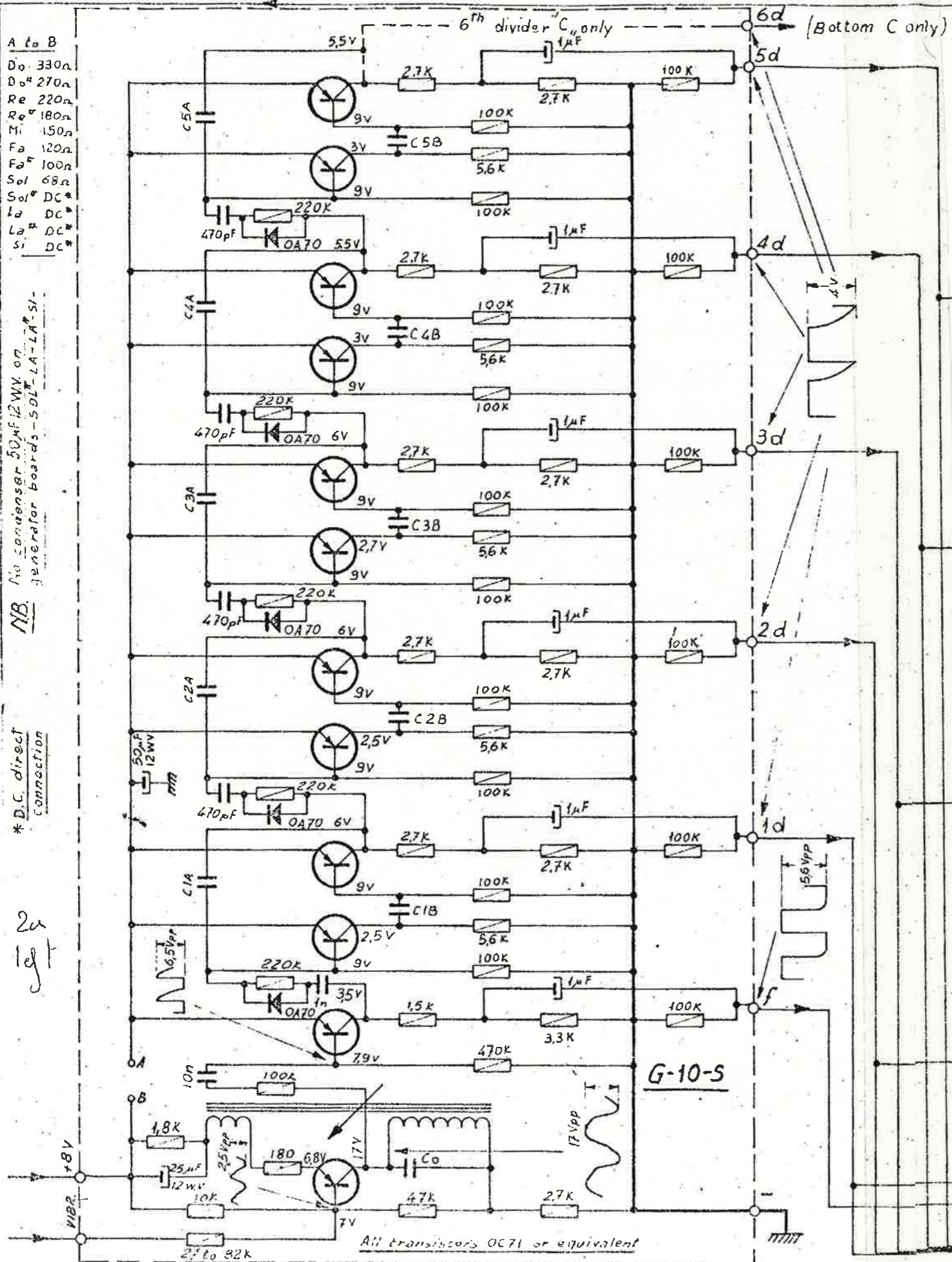

UPPER MANUAL

All transistors OC71 or equivalent

27 to 82k

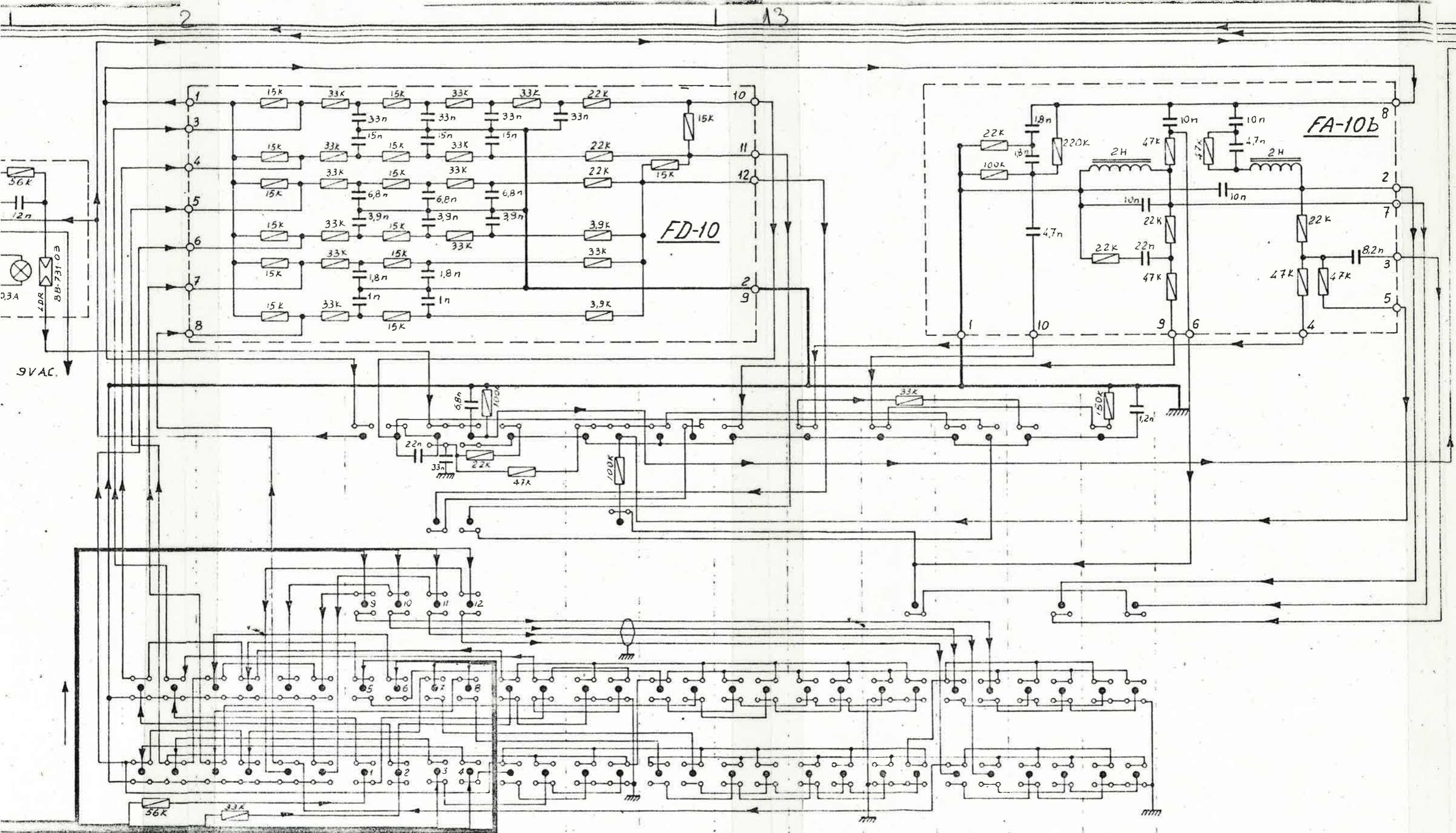

16	8	4	OFF MULTI-TONE BOOSTER ON	3a center	BASS 16	STRINGS 16	FLUTE 8	OBOE 8	TRUMPET 8	STRINGS 8	FLUTE 4	PICCOLO 4	STRINGS 4
----	---	---	------------------------------------	-----------	------------	---------------	------------	-----------	--------------	--------------	------------	--------------	--------------

3a right

17

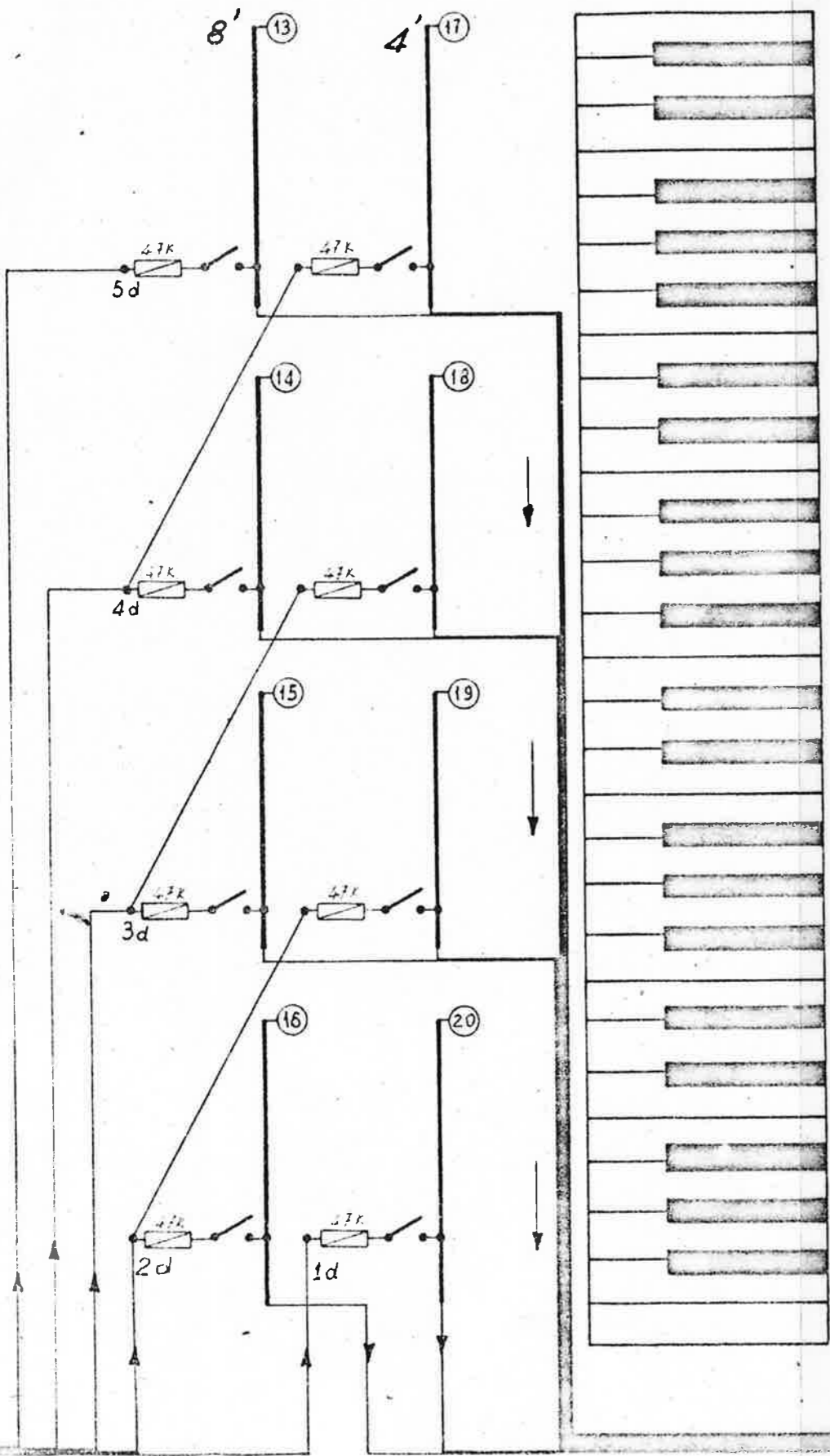

LOWER MANUAL

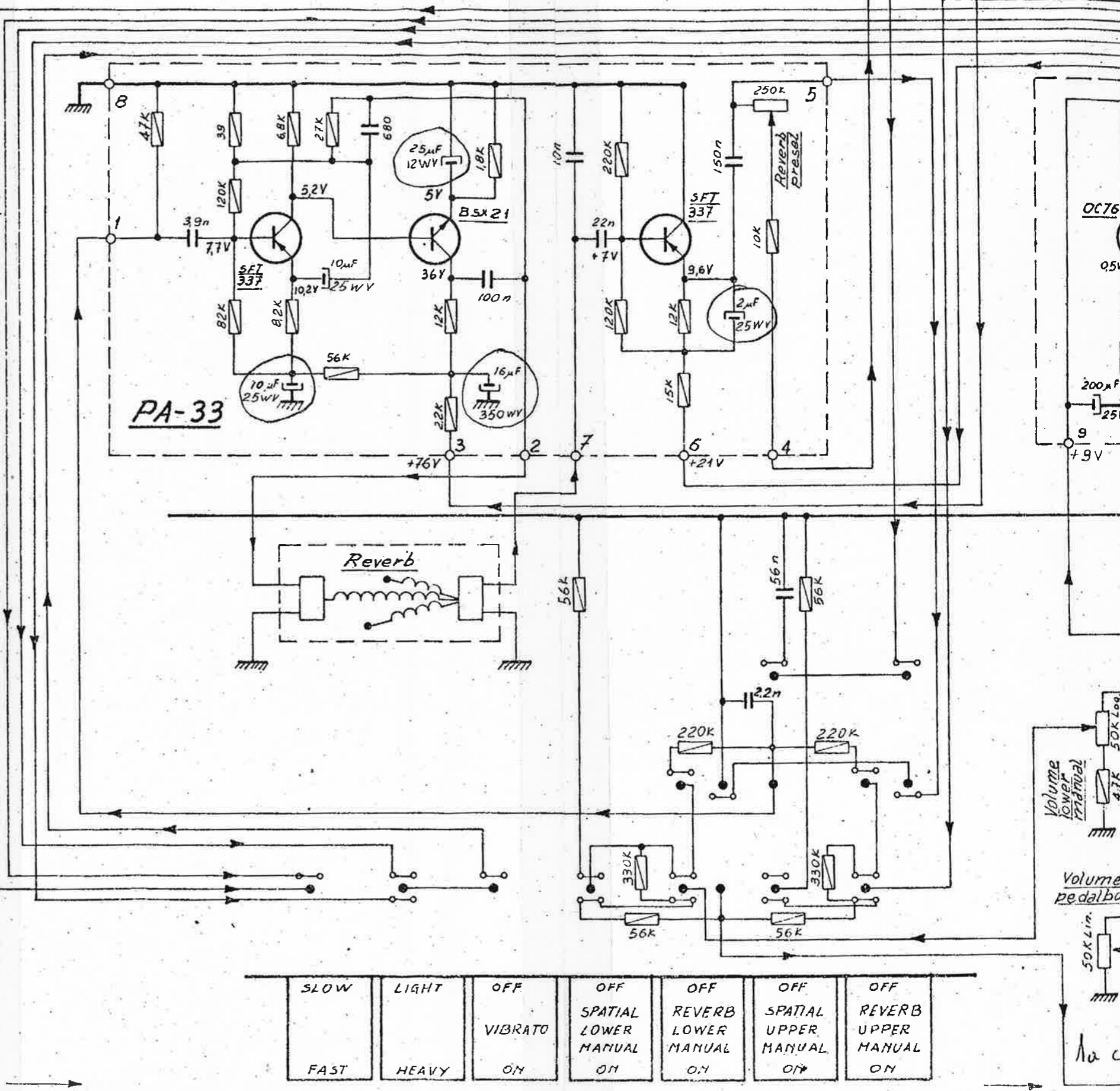

SLOW	LIGHT	OFF	OFF	OFF	OFF	OFF
FAST	HEAVY	VIBRATO	SPATIAL LOWER MANUAL	REVERB LOWER MANUAL	SPATIAL UPPER MANUAL	REVERB UPPER MANUAL
		ON	ON	ON	ON	ON

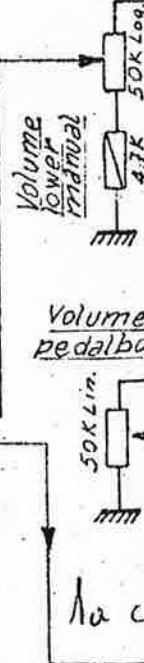

PA-16b

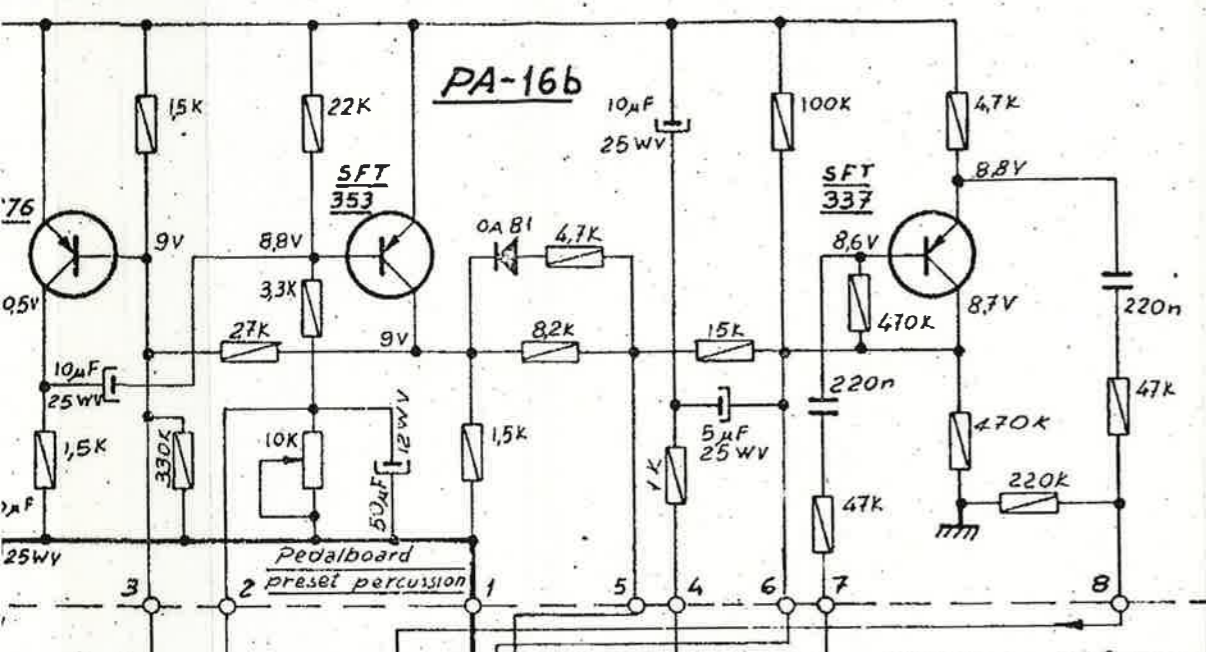

PA-15

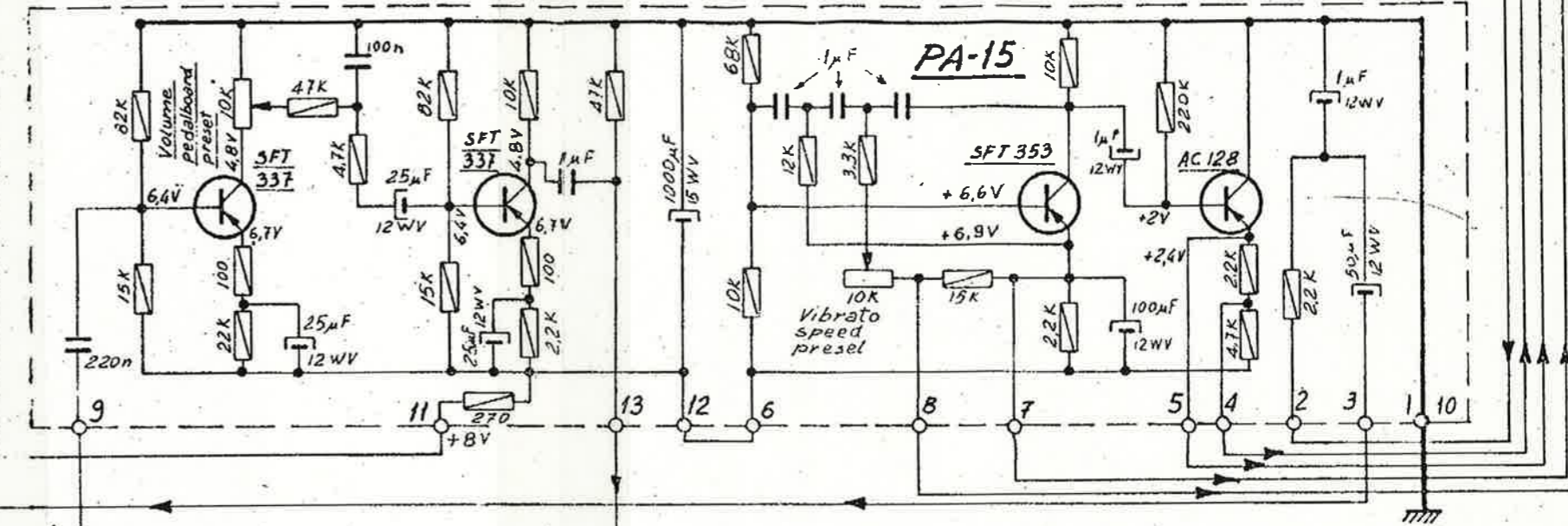

FD-20

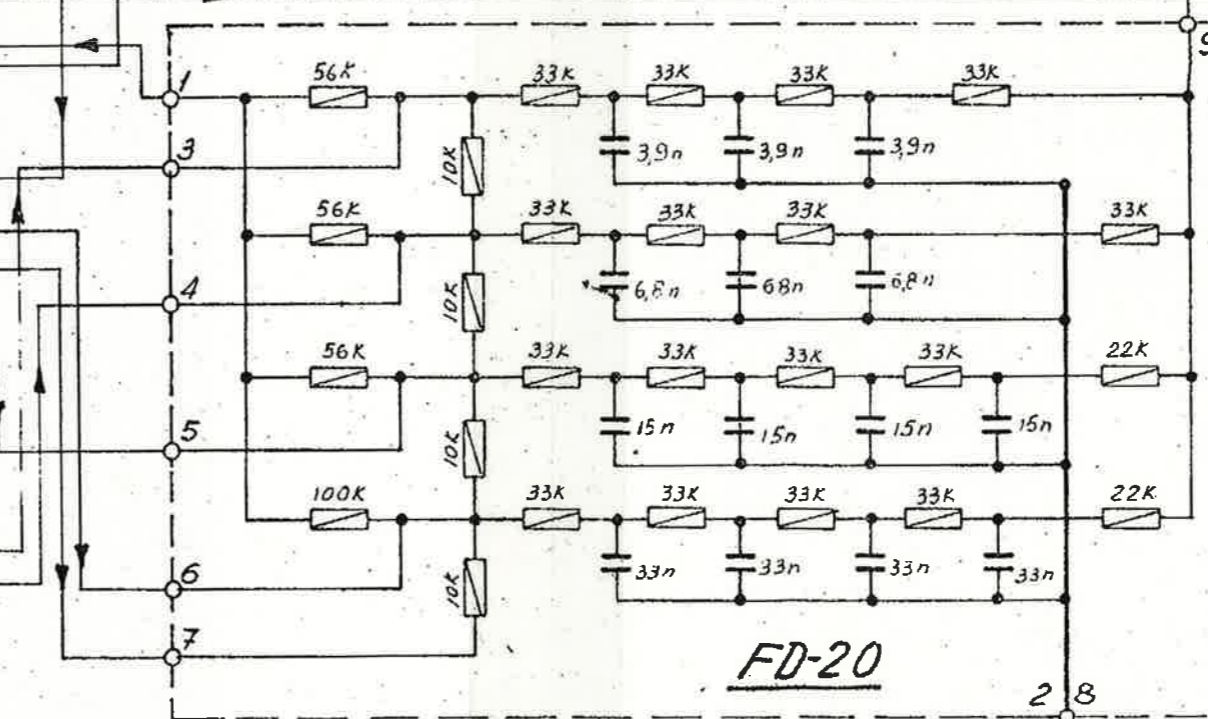

center ht

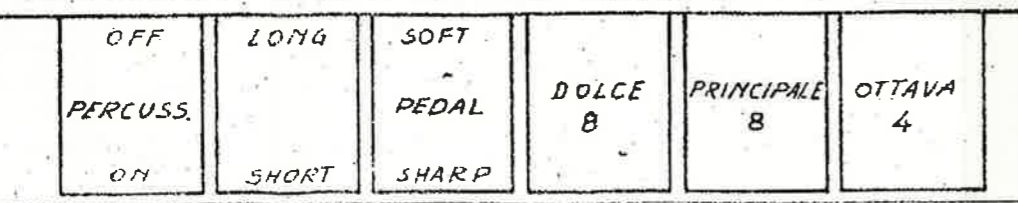

1a night suite a

1a night suite b

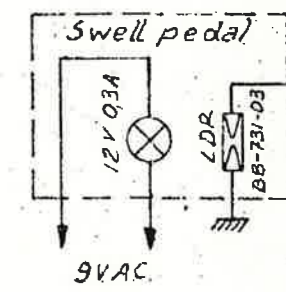

ne board

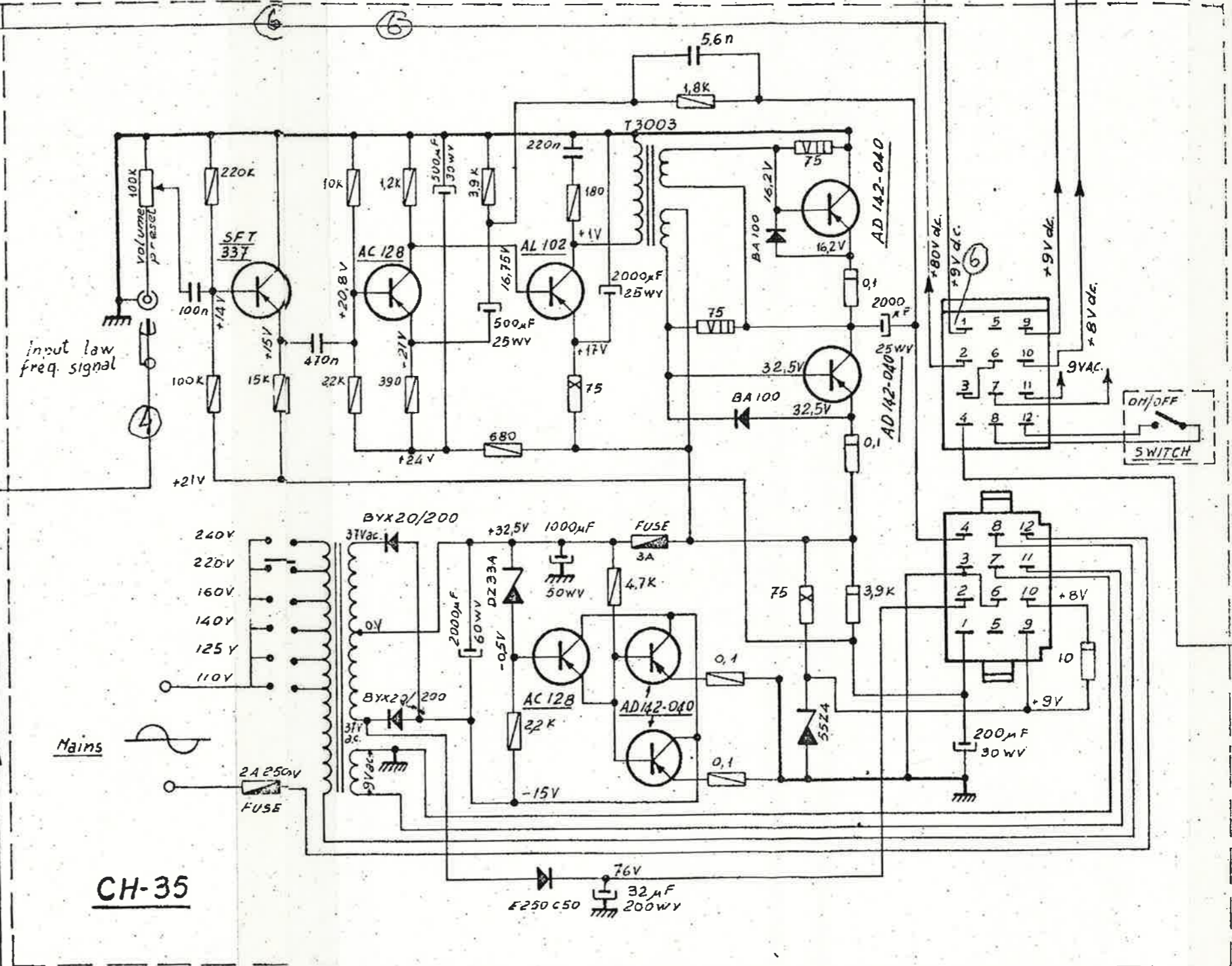
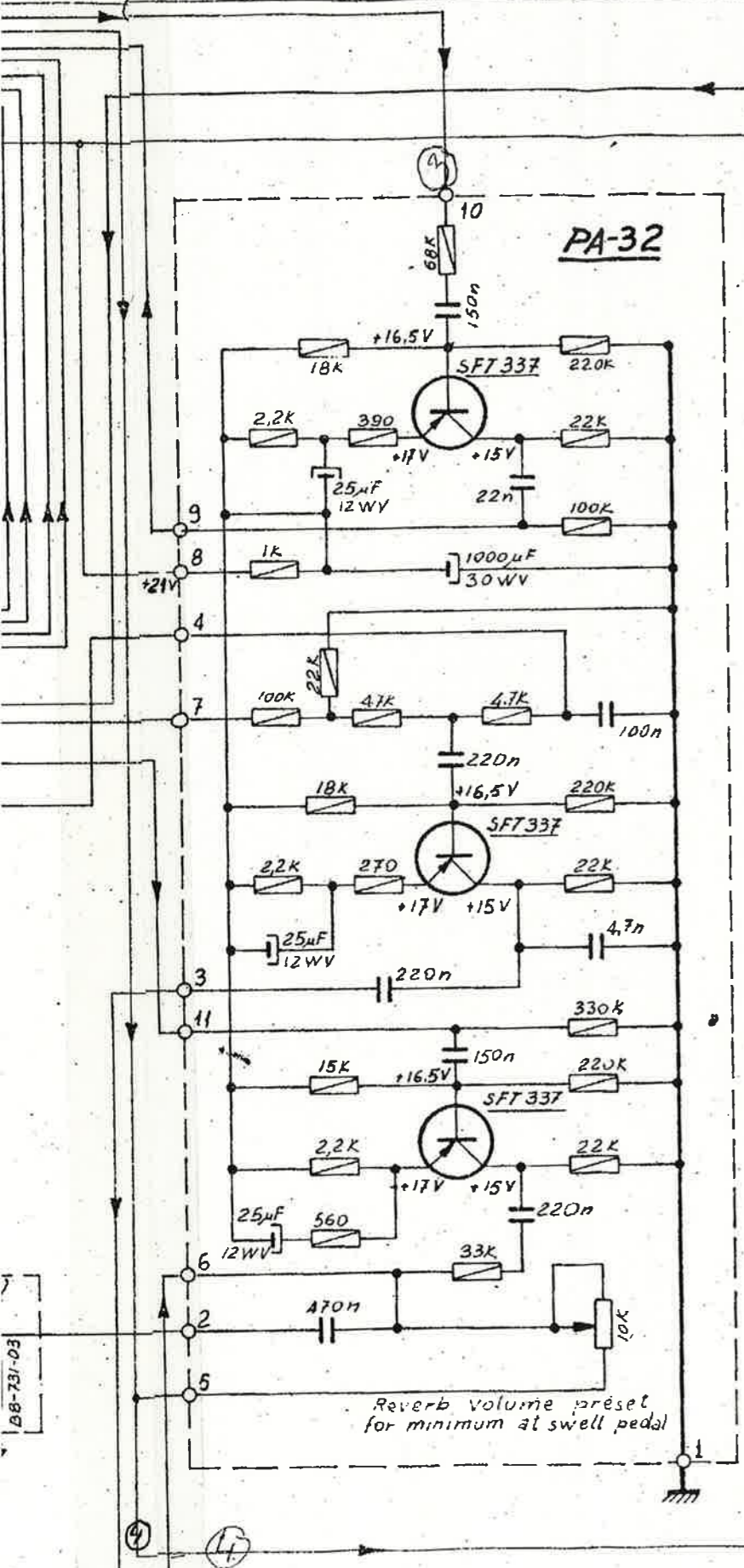

CH-35

la suite d

la night suite c

14  
Volu  
for

- DO c 6d
- DO# c# 5d
- RE D 5d
- RE# D# 5d
- MI E 5d
- FA F 5d
- FA# F# 5d
- SOL G 5d
- SOL# G# 5d
- LA A 5d
- LA# A# 5d
- SI B 5d
- DO C 5d

LEAD  
407E

pedal bo

14  
 volume trimmers  
 for each note

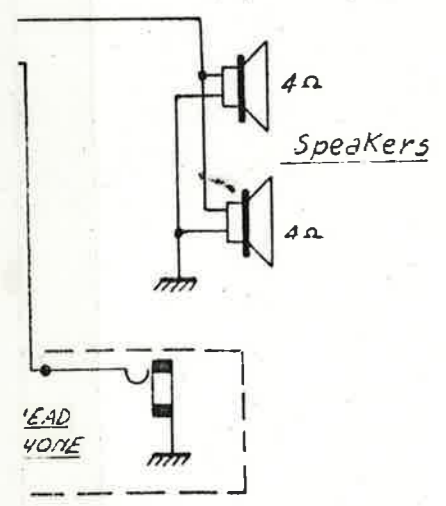
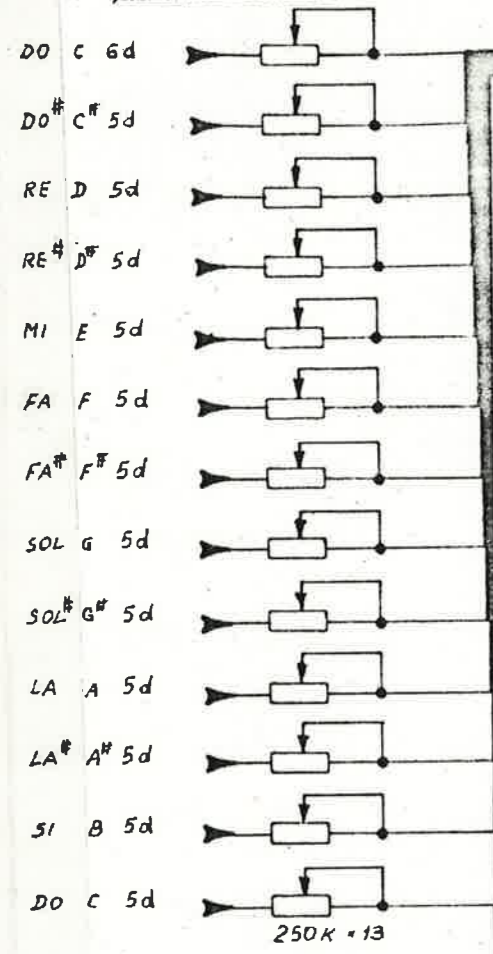

pedal board left

P2  
 P3

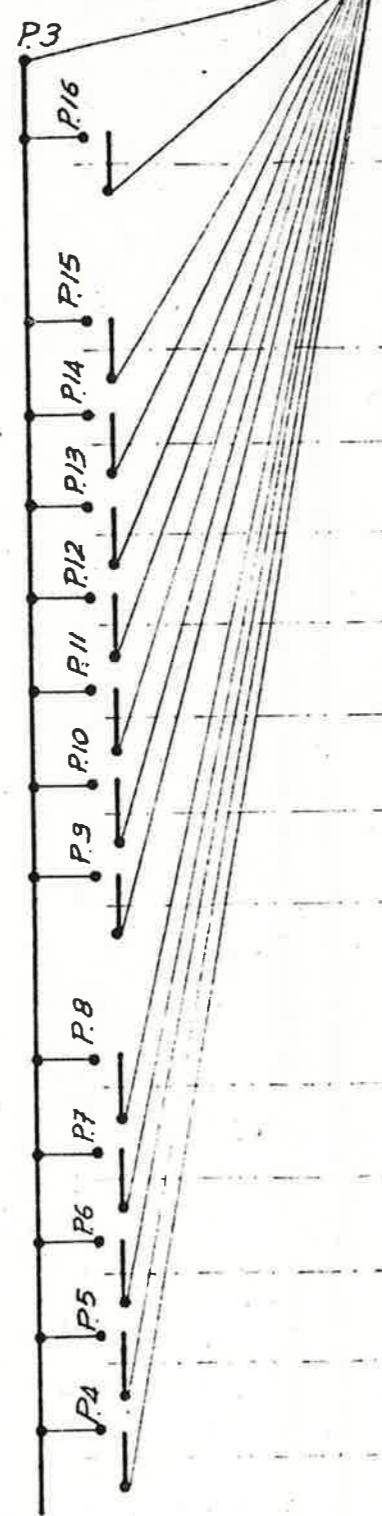

Pedal board

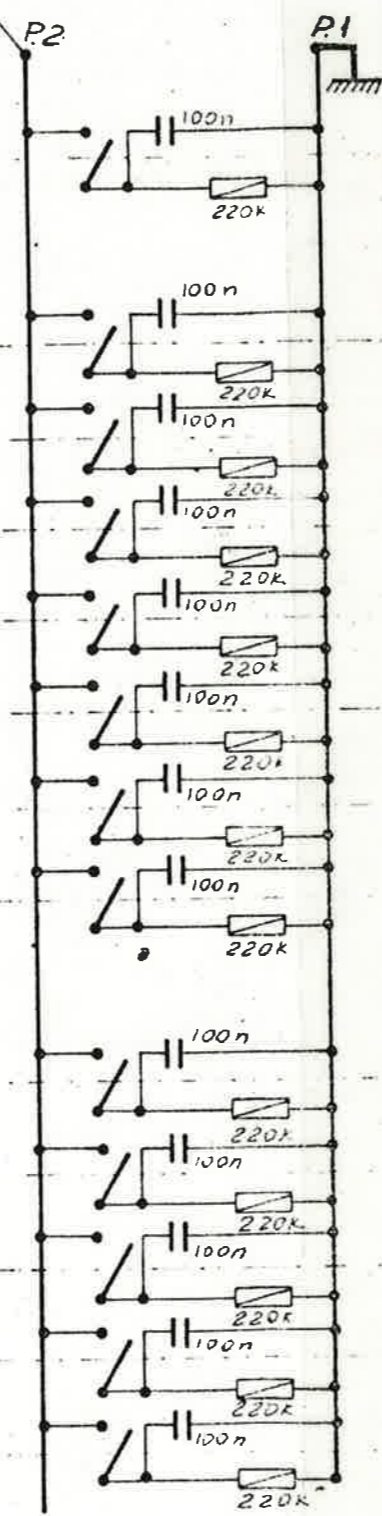

pedal board right

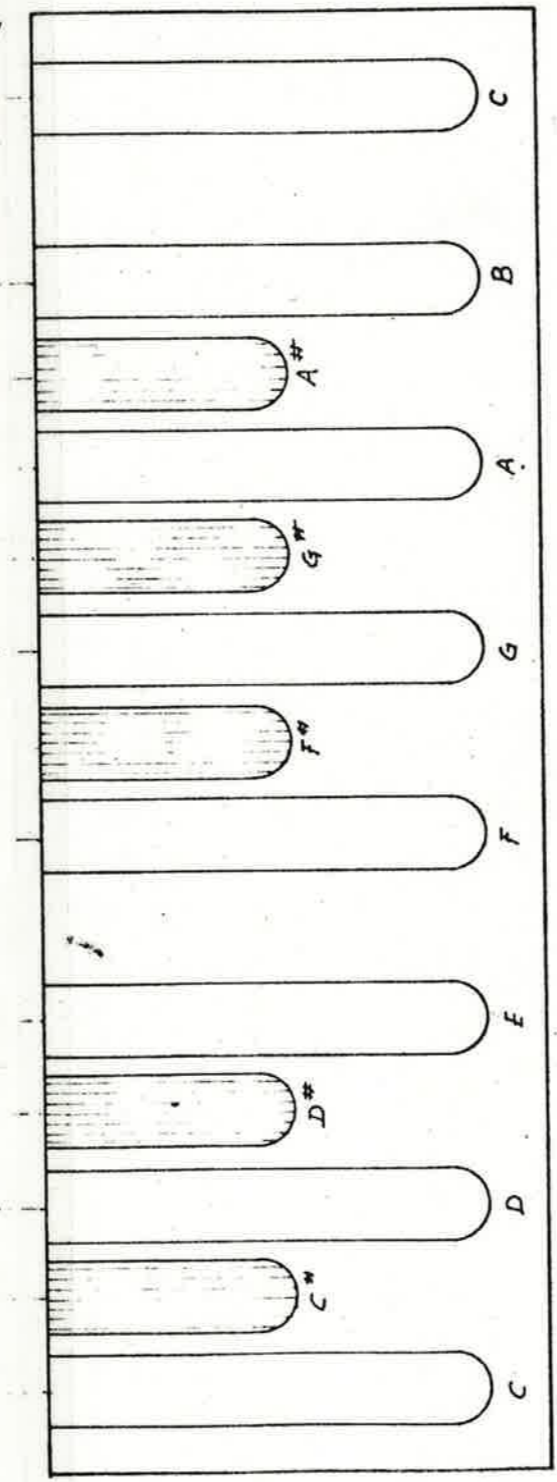

Pin No	Tone	Color code
4	C	Grey
5	C#	White
6	D	Transparent
7	D#	Pink
8	E	Black
9	F	Brown
10	F#	Red
11	G	Orange
12	G#	Yellow
13	A	Green
14	A#	Light blue
15	B	Blue
16	C	Violet

Pedal board

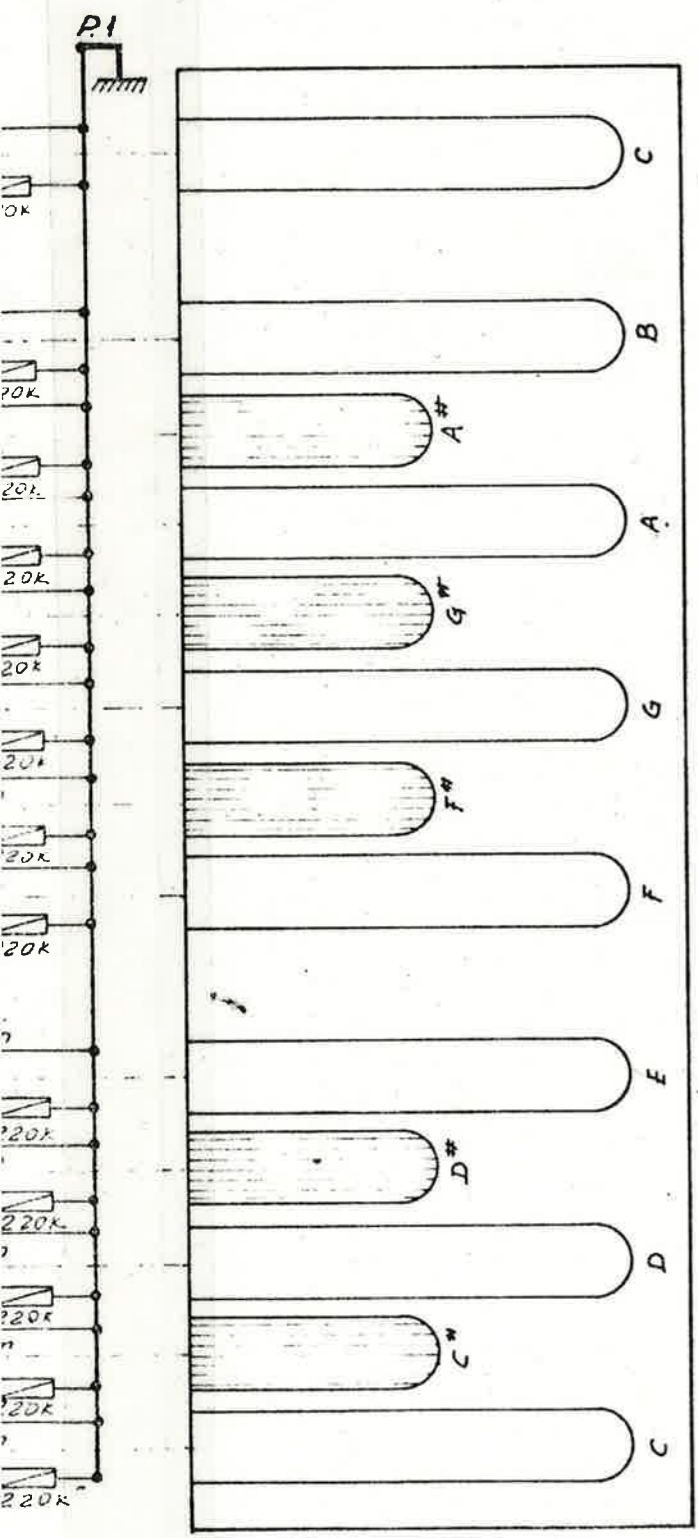

Pin No	Tone	Color code
4	C	Grey
5	C#	White
6	D	Transparent
7	D#	Pink
8	E	Black
9	F	Brown
10	F#	Red
11	G	Orange
12	G#	Yellow
13	A	Green
14	A#	Light blue
15	B	Blue
16	C	Violet

16

	C0	C1A	C1B	C2A	C2B	C3A	C3B	C4A	C4B	C5A	C5B	C6A	C6B
C DO	7,5n	5,6n	6,8n	12n	12n	22n	27n	39n	47n	82n	100n	150n	170n
C# DO#	16n	10n	12n	27n	27n	39n	39n	82n	82n	150n	150n		
D RE	14,7n	10n	10n	18n	22n	39n	39n	68n	82n	150n	150n		
D# RE#	13n	8,2n	10n	18n	22n	39n	39n	68n	82n	150n	150n		
E MI	11,2n	8,2n	10n	18n	22n	33n	39n	68n	82n	120n	150n		
F FA	10n	8,2n	10n	15n	18n	33n	39n	68n	68n	120n	150n		
F# FA#	9n	6,8n	10n	15n	18n	27n	33n	56n	68n	120n	120n		
G SOL	7,8n	6,8n	10n	12n	15n	27n	33n	56n	68n	100n	120n		
G# SOL#	7,1n	6,8n	8,2n	12n	15n	27n	33n	56n	68n	100n	100n		
A LA	5,9n	5,6n	8,2n	12n	15n	22n	33n	47n	68n	100n	100n		
A# LA#	10n	5,6n	6,8n	10n	12n	22n	33n	47n	56n	82n	100n		
B SI	8,3n	5,6n	6,8n	10n	12n	22n	27n	47n	47n	82n	100n		

Values of G10/s generator boards' dividers

pedal board right

Resistors	Capacitors
= 1/2 watt	= 125 WV
= 1 watt	= 400 WV
= 7 watts	= 630 WV
= 10 watts	